

STANDARD FENCE DETAIL

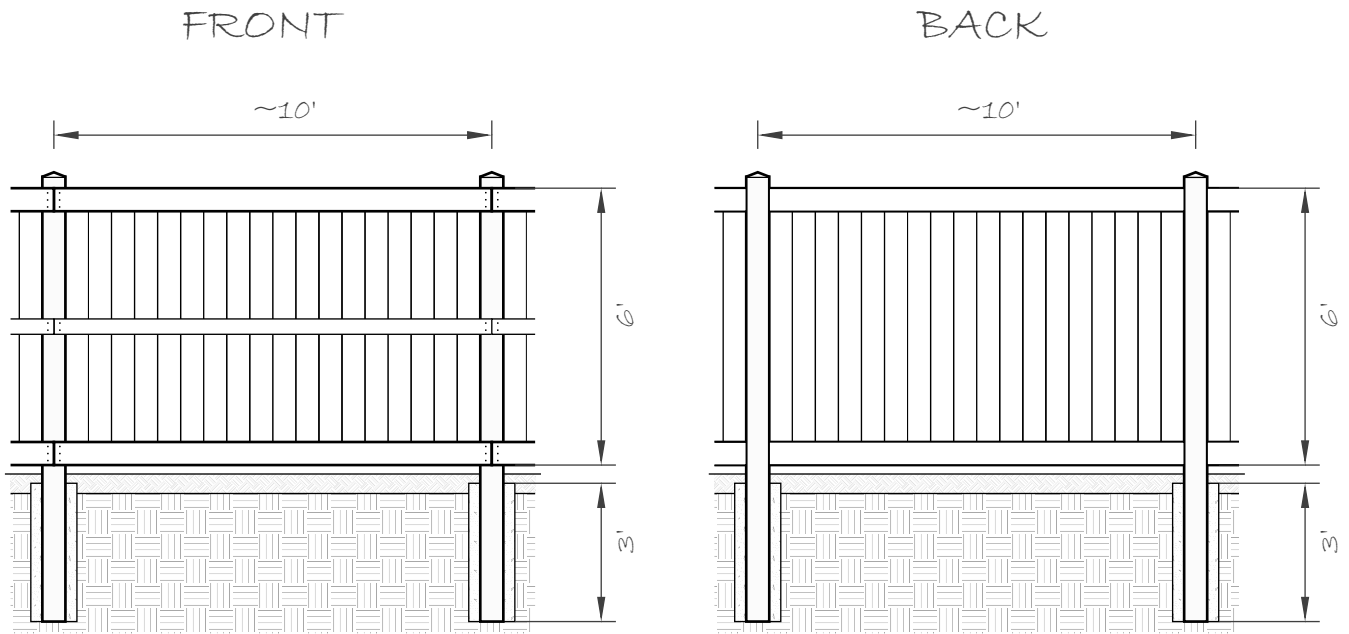

Scale 1mm:50mm

NOTES:

- ~PRESSURE TREATED LUMBER UNLESS OTHERWISE NOTED.
- ~POSTS TO BE SET IN CONCRETE
- ~POSTS TO BE BURIED AT LEAST 36" DEEP.
- ~BOTTOM STRINGER TO BE AT LEAST 1" ABOVE FINISHED LANDSCAPE.
- ~MIDDLE STRINGER TO BE CENTRED BETWEEN TOP AND BOTTOM STRINGER.

This is a concept drawing ONLY.
The actual layout will be custom fit to each yard.

POST TOP DETAILS

CHOOSE YOUR POST CUT

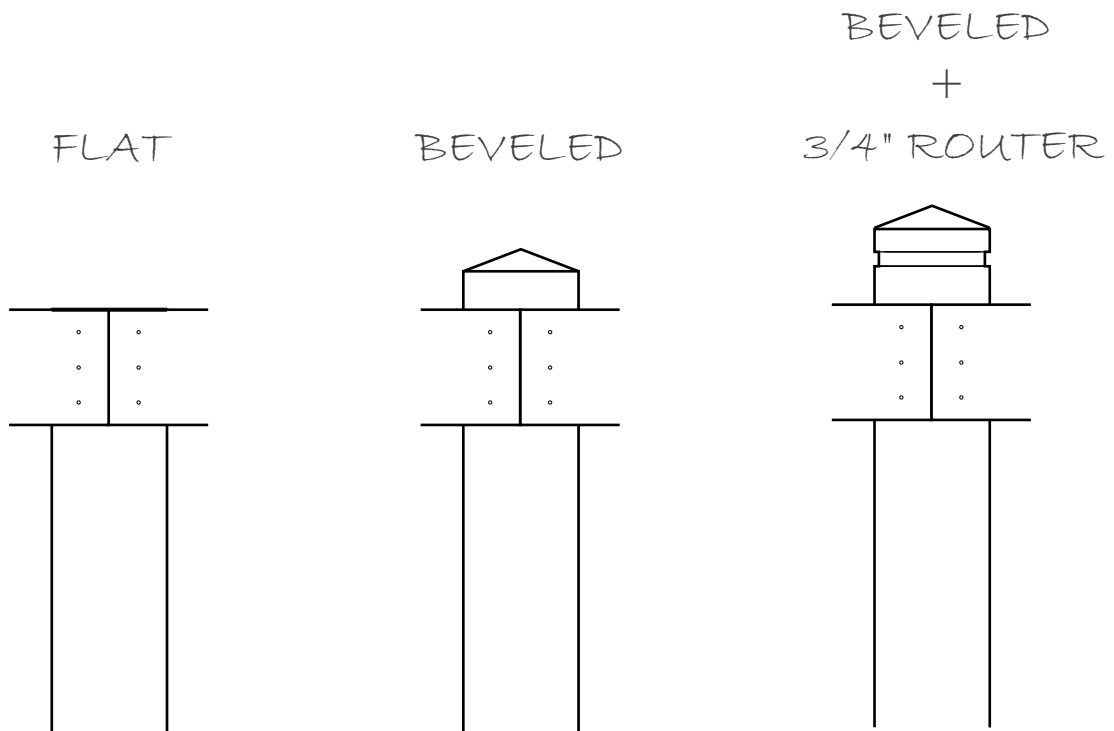

Scale 1mm:10mm

NOTES:

~PRESSURE TREATED LUMBER UNLESS OTHERWISE NOTED.

~BEVEL TO BE 22.5 DEGREES.

~3/4" ROUTER TO BE 1/4" DEEP

This is a concept drawing ONLY.
The actual layout will be custom fit to each yard.

STANDARD GATE DETAILS

CHOOSE YOUR GATE

STANDARD

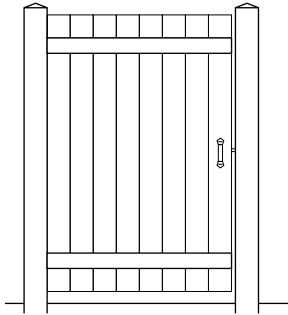

Z-PATTERN

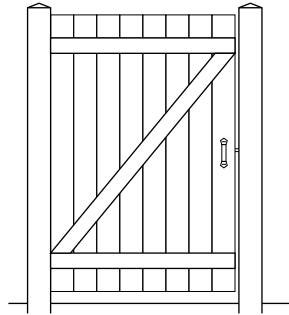

PICTURE FRAME

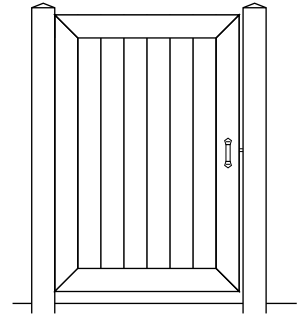

STANDARD
W/ARBOR

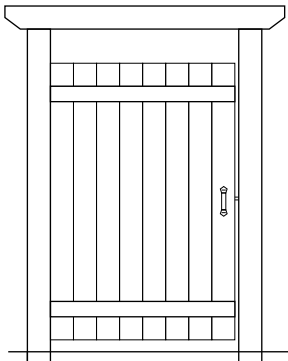

Z-PATTERN
W/ARBOR

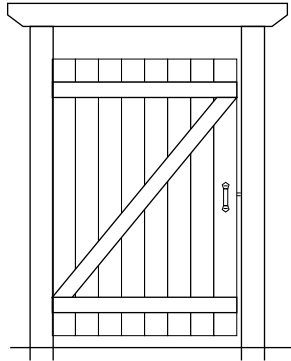

PICTURE FRAME
W/ARBOR

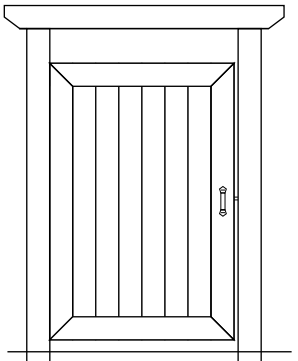

Scale 1mm:50mm

NOTES:

- ~PRESSURE TREATED LUMBER UNLESS OTHERWISE NOTED.
- ~LATCHES AND GATE HARDWARE TO BE BLACK.
- ~GATE TO HINGE FROM POST AT LOWEST POINT (TYPICALLY PROPERTY LINE).
- ~BOTTOM OF GATE TO BE AT LEAST 2' ABOVE FINISHED LANDSCAPE.
- ~THE DIMENSIONS OF EACH GATE ARE UNIQUE, AND WILL BE CUSTOM BUILT TO SUIT CONDITIONS.

This is a concept drawing ONLY.
The actual layout will be custom fit to each yard.